

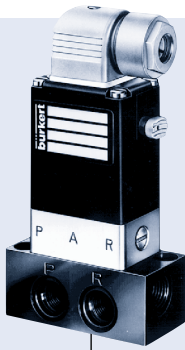

3/2-way Solenoid Valve sub-base connection



- 3-way solenoid valve with pivoted armature and manual override
- Direct-acting with isolating diaphragm
- Fast-acting
- For liquid, gaseous and aggressive media
- Long service life, even in non-lube conditions
- 

Type 0331 can be combined with...

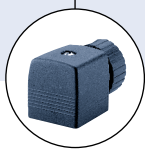

Type 2508
Cable plug



Type 1078
Timer unit

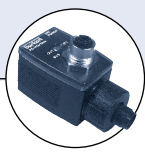

Type 2511
ASI cable plug



Type 8600
Dosing control

The Type 0331 is a direct-acting 3/2-way pivoted armature solenoid valve for sub-base mounting. The magnetic system and the media chamber are separated from one another by a separating diaphragm system.

The valve is fast acting and has a long service life, even when run dry.

Power consumption			
Inrush		Hold	
AC [VA]	DC [W]	AC [VA/W]	DC [W]
30	8 or 5	15/8	8 or 5

Technical data	
Orifice	DN 2.0 – 4.0 mm
Body and seat materials	Brass and stainless steel 316
Seal material	FKM
Media NBR EPDM FKM	Neutral media such as compressed air, water, hydraulic oil Oil and fat-free media Hot air, oxygen
Media temperature NBR EPDM FKM	32°F to 176°F (0°C to +80°C) -22°F to 194°F (-30°C to +90°C) 32°F to 194°F (0°C to +90°C)
Ambient temperature	Max. 131°F (+55°C)
Viscosity	Max. 37 cst
Voltage tolerance	±10%
Duty cycle	60% continuous rating when mounted on manifold
Electrical connection	DIN 43650, form A
Protection class	IP 65 with cable plug Type 2508 or 2509
Installation	As required, preferably with actuator upright

Possible connections and dimensions

Possible connections			
Circuit function	1	2	3
A	P	A	-
B	-	B	P
C	P	A	R
D	R	B	P
E or T	P1	A	P2
F	A	P	B

The ports marked with 1, 2 and 3 in the drawing are marked as in the allocation table, depending on the circuit function.

Dimensions

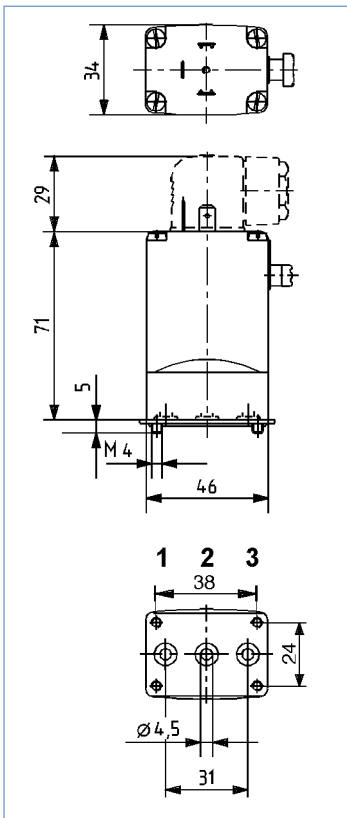

DTS 1000082553 EN Version: A Status: RL (released | freigegeben | valide) printed: 20.01.2015

The valves are fitted with different springs. When used in other circuit functions, the permissible operating pressure changes according to the following table.

Circuit function	Max. operating pressure [PSI] for valve use in other circuit function																	
	Orifice 2 [mm]						Orifice 3 [mm]						Orifice 4 [mm]					
WW	A	B	C	D	E	F	A	B	C	D	E	F	A	B	C	D	E	F
C	232	21	232	21	21	232	145	14.5	145	14.5	14.5	145	72	11.6	72	11.6	11.6	72
D	58	377	65	232	58	58	36	145	36	145	29	43	29	72	29	72	29	29
E or T	116	116	145	145	145	116	87	87	87	87	87	87	43	43	43	43	43	43
F	145	21	145	21	21	232	87	14.5	87	14.5	14.5	145	58	11.6	58	11.6	11.6	72

Ordering chart for valves (other versions on request)

All valves with sub-base connection, manual override and cable plug, body material stainless steel or brass

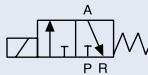
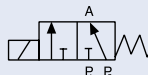
Circuit function	Orifice [mm]	Port connection	Cv value water [GPM]	Pressure range [PSI]	Seal material	Body material	Voltage/frequency [V/Hz]	Item no. UL Recognized/ CSA/CE Cable plug not included	Item no. UL/FM Class 1, Div 2/CSA/CE Includes 1/2" conduit plug type 2509
C 3/2-way valve NC 	2.0	Sub-base	0.09	0 – 174	FKM	Stainless steel	024/DC	451 745	–
			0.09	0 – 174	FKM	Brass	024/DC	*450 831	453 029
			0.11	0 – 174	FKM	Stainless steel	024/60	*456 491	453 028
							120/60	*455 518	453 027
							240/60	–	453 264
			3.0	Sub-base	0.14	0 – 145	FKM	Stainless steel	024/DC
	0.17	0 – 145			FKM	Brass	120/60	460 133	–
	0.14	0 – 145			FKM	Stainless steel	024/DC	*450 829	453 266
							024/60	–	453 268
							120/60	450 305	453 270
	240/60	450 587			453 272				
	4.0	Sub-base	0.25	72	FKM	Brass	024/DC	458 995	–
120/60			459 002	–					
240/60			459 001	–					
0.09			0 – 174	FKM	Brass	024/DC	*450 792	453 032	
						024/60	451 757	453 031	
						120/60	451 758	453 030	
240/60	–	–							
3.0	Sub-base	0.14	0 – 145	FKM	Brass	024/DC	*450 830	453 279	
		0.17	0 – 145	FKM	Stainless steel	024/60	*454 396	–	
		120/60	451 764	459 041	240/60	–	–		
						–	–		
						–	–		
		E 3/2-way 	2.0	Sub-base	0.09	0 – 145	FKM	Brass	024/DC
0.11	0 – 145				FKM	Stainless steel	024/60	–	–
120/60	453 768				–				
240/60	–		–						
3.0	Sub-base		0.14	0 – 87	FKM	Brass	024/DC	*455 541	–
			0.17	0 – 87	FKM	Stainless steel	024/60	–	–
			120/60	–	451 927				
			240/60	–	–				
			–	–	–				
		–	–	–					

Vacuum versions available on request

FM Class1, Div 1, Versions available on request

* CE approved only

** See 2509 datasheet for plug dimensions

Ordering chart for flange valve manifolds and accessories (All manifolds made of anodised aluminium)

Manifold	Length A [mm]	Hole spacing B [mm]	Item no.
1 valve	32	-	613 983
2 valves	69	-	006 110
3 valves	106	37	613 706
4 valves	143	74	006 111
5 valves	180	111	613 704
6 valves	217	148	613 703

Accessory parts		
Connector nipple		005 049
Covering plate for unused valve positions		005 625

Dimensions

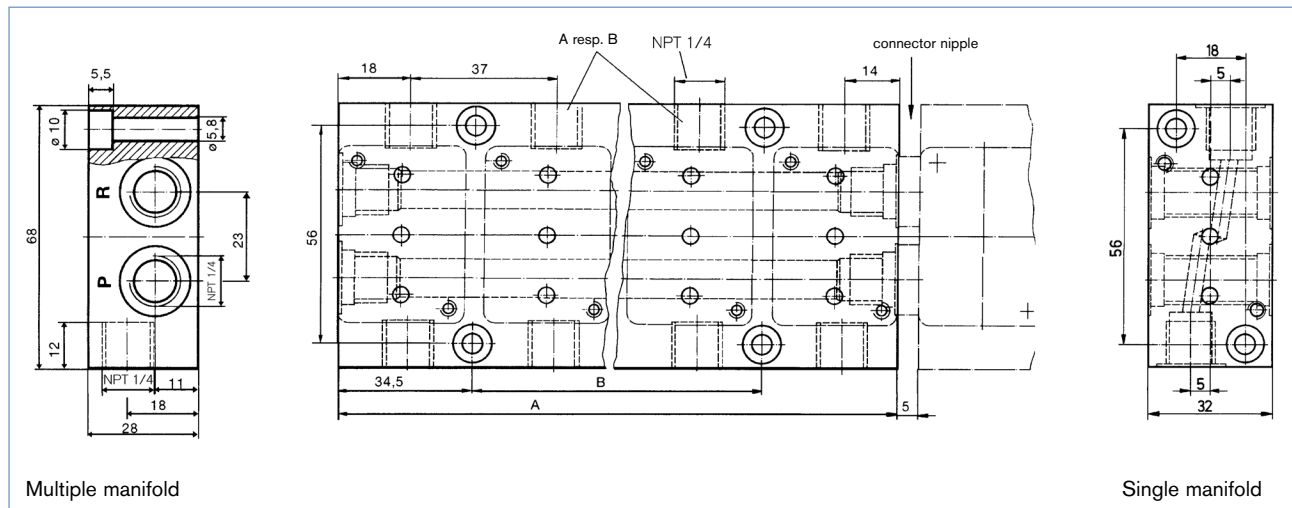

DTS 1000082553 EN Version: A Status: RL (released | freigegeben | valide) printed: 20.01.2015

In case of special application conditions, please consult for advice.

We reserve the right to make technical changes without notice.

1409/4_US-en